

User Manual

IR IP CAMERA





WARNINGS

TO REDUCE THE RISK OF FIRE OR ELECTRIC SHOCK, DO NOT EXPOSE THIS PRODUCT TO RAIN OR MISTURE.

DO NOT INSERT ANY METALLIC OBJECT THROUGH VENTILATION GRILLS.

CAUTION

	CAUTION RISK OF ELECTRIC SHOCK DO NOT OPEN	
CAUTION : TO REDUCE THE RISK OF ELECTRIC SHOCK. DO NOT REMOVE COVER (OR BACK). NO USER-SERVICEABLE PARTS INSIDE. REFER SERVICING TO QUALIFIED SERVICE PERSONNEL.		

COPYRIGHT

THE TRADEMARKS MENTIONED IN THE MANUAL ARE LEGALLY REGISTERED TO THEIR RESPECTIVE COMPANIES.

Content

I. PREFACE	4
II. PRODUCT SPECIFICATIONS	4
III. PRODUCT INSTALLATION	6
A. MONITOR SETTING	6
B. HARDWARE INSTALLATION AND I/O PIN ASSIGNMENT	8
C. IP ASSIGNMENT	12
D. INSTALL ACTIVE X CONTROL	14
IV. LIVE VIDEO	16
V. CONFIGURATION	18
A. SYSTEM	19
B. NETWORK	22
C. A/V SETTING	26
D. EVENT LIST	33
VI. NETWORK CONFIGURATION	40
VII. FACTORY DEFAULT	42
VIII. PACKAGE CONTENTS	42
APPENDIX I	42

I. Preface

This is a 2M-Pixel CMOS IP camera with the web server built in. User can view real-time video via IE browser. It supports H.264, JPEG and MPEG4(3GPP Only) video compression which provides smooth and high video quality. The video can be stored in the SD card and playback remotely.

With user friendly interface, it is an easy-to-use IP camera which is designed for security application.

II. Product Specifications

- Support video out
- High Definition 30FPS support(720P)
- IP66
- 2M-Pixel CMOS Sensor
- Power over Ethernet available
- IR LED Built in 20M available
- Mechanism IR Cut Filter Available
- H.264/ MJPEG/ MPEG4 (3GPP Only) Compression Format
- SD Card backup
- 2-way audio
- Support Cell phone/PDA/3GPP
- SDK for Software Integration
- Free Bundle 36 Channel Recording Software

Specifications

Hardware	
CPU	ARM 9 ,32 bit RISC
RAM	256MB
Flash	16MB
Image Sensor	1/3" CMOS(2M-Pixel)
Support DC IRIS	Yes
Lens Type	Vari-focal 3.6~16mm Lens

ICR	Mechanism IR cut Filter
LED	Built-in 35 IR LED
	IR Distance-20M
I/O	1 in/ 1 Relay Out
Video Out	x1
Audio In	x1
Audio Out	x1
Power over Ethernet	Yes (Optional)
Power Consumption	DC 12V
Dimensions	∅ 83mm * H180mm
Network	
Ethernet	10/ 100 Base-T
Network Protocol	HTTP, TCP/ IP, UDP, SMTP, FTP, PPPoE, DHCP, DDNS, NTP, UPnP, 3GPP
System	
Video Resolution	1600x1200, 1280x1024, 1280x960, 1280x720, 800x600, 640x480, 320x240, 176x144
Video Adjust	Brightness, Contrast, Sharpness, BLC, Night Mode
Triple Streaming	Yes
Image Snapshot	Yes
Full Screen Monitoring	Yes
Privacy Mask	Yes, 3 different areas
Compression Format	H.264/ JPEG/ MPEG4 (3GPP only)
Video Bitrates Adjust	CBR, VBR
Motion Detection	Yes, 3 different areas
Triggered Action	Mail, FTP, Save to SD card, Relay
Pre/ Post Alarm	Yes, configurable
Security	Password protection
Firmware Upgrade	HTTP mode, can be upgraded remotely
Simultaneous Connection	Up to 10
Audio	Yes, 2-way
SD card management	

Recording Trigger	Motion Detection, IP check, Network break down (wire only), Schedule, Relay
Video Format	AVI, JPEG
Video Playback	Yes
Delete Files	Yes
Web browsing requirement	
OS	Windows 2000, XP, 2003, Microsoft IE 6.0 or above
Hardware	
Suggested	Intel Dual Core 1.66G, RAM: 1024MB, Graphic card: 128MB
Minimum	Intel-C 2.8G, RAM: 512MB, Graphic card: 64MB

III. Product Installation

A. Monitor Setting

- i. Right-Click on the desktop. Select “ Properties”



- ii. Change color quality to highest (32bit).

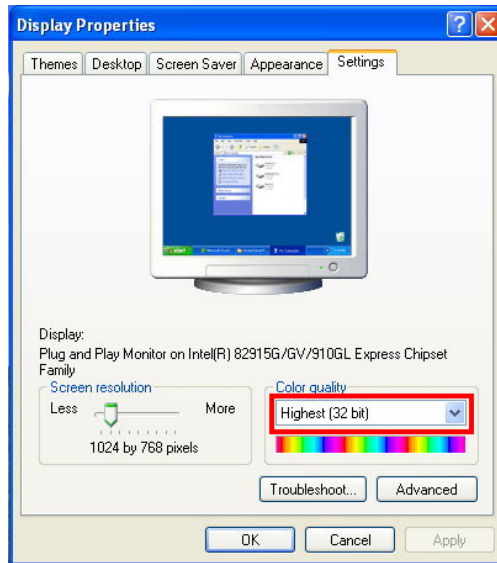

B. Hardware Installation and I/O Pin

Assignment

- i. Connect a power adapter and IP Camera to PC or local network

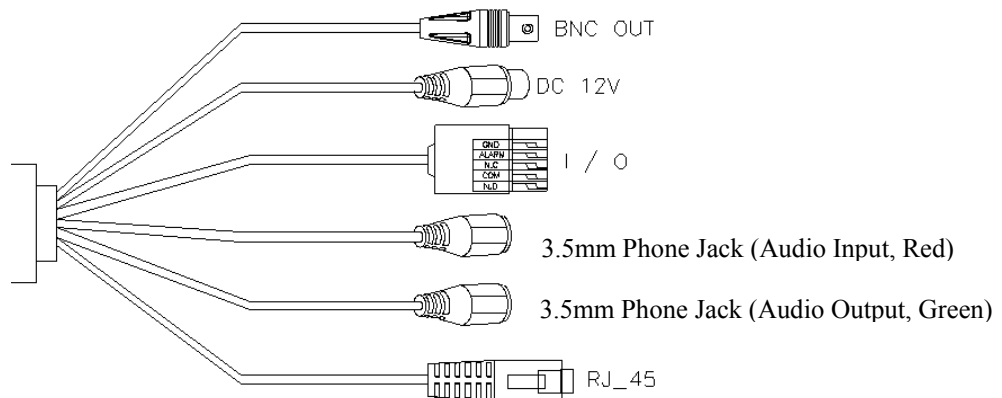

- ii. I/O Control Instruction

I/O terminal connector – used in application, for e.g., motion detection, event triggering, alarm notifications. It provides the interface to:

1 Digital Input (GND+Alarm) – An alarm input for connecting devices that can toggle between an open and closed circuit, for example: PIRs, door/window contacts, glass break detectors, etc. When a signal is received the state changes and the input becomes active.

Relay output (COM +N.O.) / (COM+N.C.) – An output to Relay switch, for example: LEDs, Sirens, etc

Digital Input

Alarm Input

1. GND (Ground) : Initial state is LOW
2. Alarm : Max. 50mA, DC 3.3V

Relay Output

1. N.C. (Normally Close): Max. 1A, 24VDC or 0.5A, 125VAC
2. COM: (Common)

3. N.O. (Normally Open): Max. 1A, 24VDC or 0.5A, 125VAC

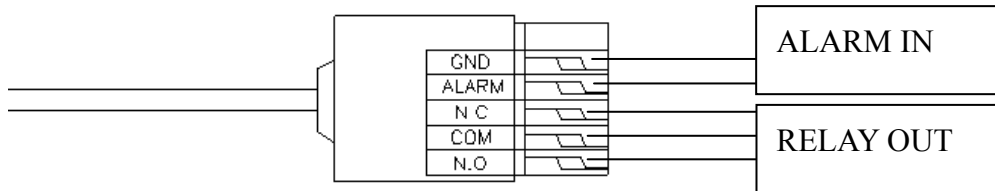

Relay

1. Digital Input connection

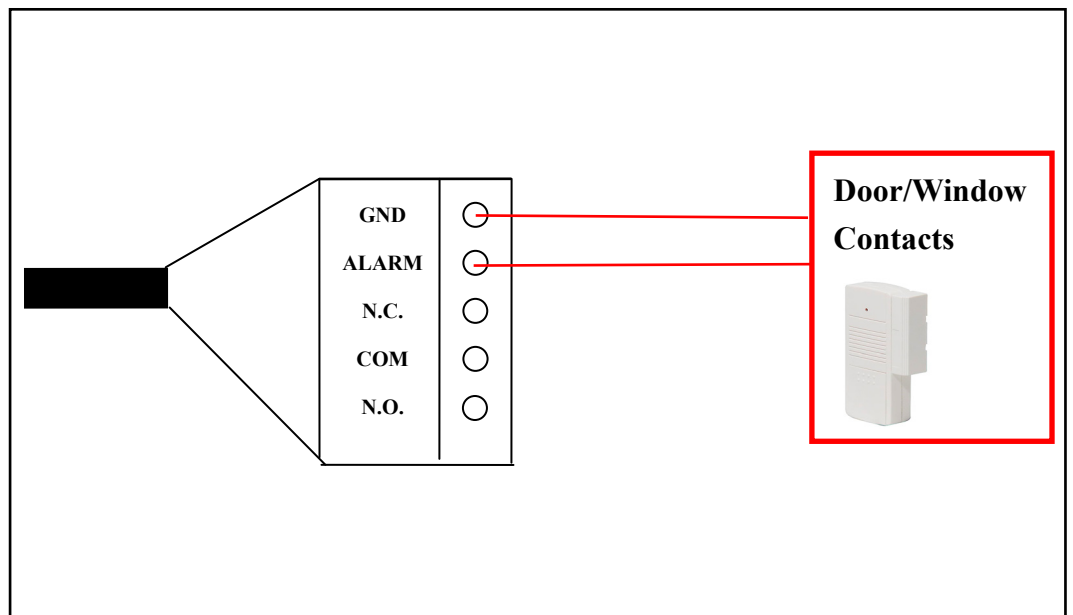

2. Relay Output Connection

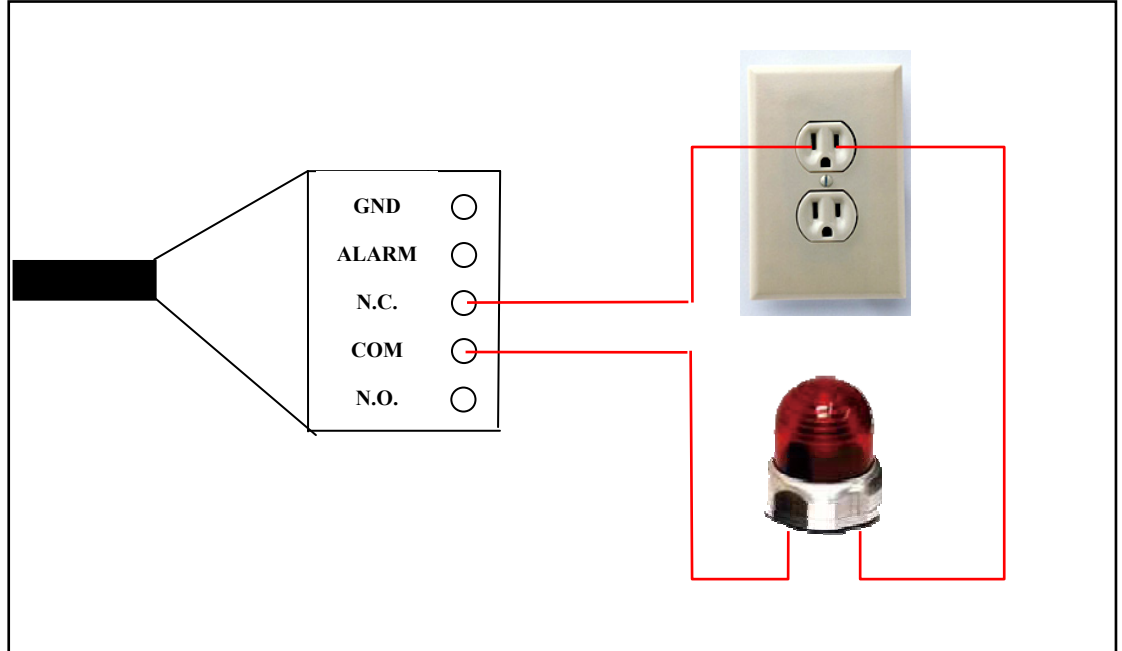

Or

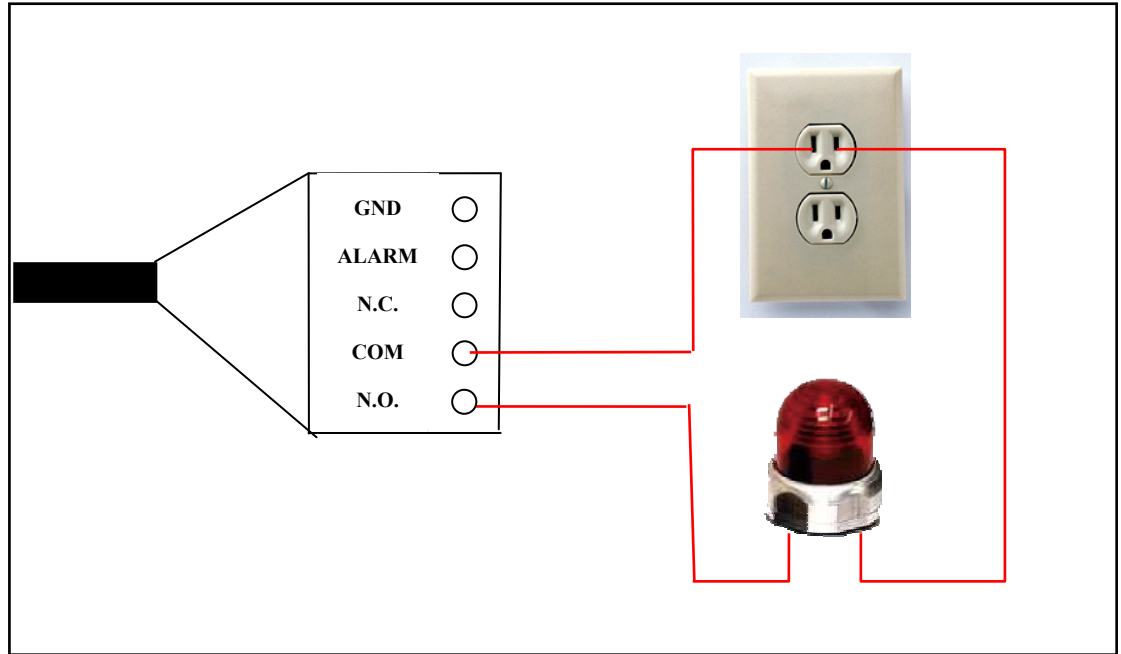

- iii. PoE (Power Over Ethernet)(Optional) **802.3af, 15.4W PoE Switch is recommended**

Power over Ethernet (PoE) is a technology that integrates power into a standard LAN infrastructure. It enables power to be provided to the network device, such as an IP phone or a network camera, using the same cable as that used for network connection. It eliminates the need for power outlets at the camera locations and enables easier application of uninterruptible power supplies (UPS) to ensure 24 hours a day, 7 days a week operation.

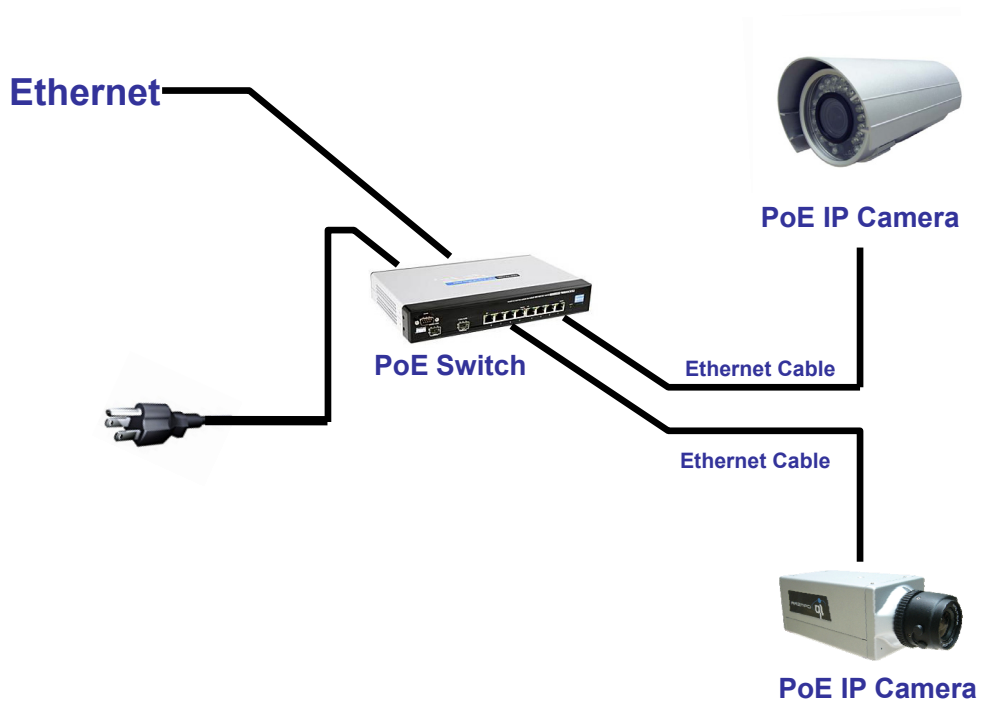

C. IP Assignment

- i. Use the software, “IP Installer” to assign the IP address of IP CAMERA. The software is in the attached software CD.
- ii. IP installer supports two languages
 - a. IPInstallerCht.exe : Chinese version
 - b. IPInstallerEng.exe : English version
- iii. There are 3 kinds of IP configuration.
 - a. Fixed IP (Public IP or Virtual IP)
 - b. DHCP (Dynamic IP)
 - c. Dial-up (PPPoE)
- iv. Execute IP Installer
- v. For Windows XP SP2 user, it may popup the following message box. Please click “Unblock”.



- vi. IP Installer configuration:

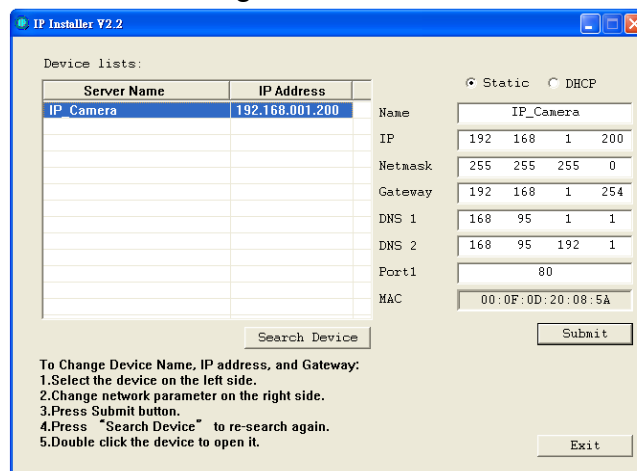

- vii. IP Installer will search all IP Cameras connected on Lan. The user can click “Search Device” to search again.

- viii. Click one of the IP Camera listed on the left side. The network configuration of this IP camera will show on the right side. You may change the “name” of the IP Camera to your preference (eg: Office, warehouse). Change the parameter and click “Submit” then click “OK”. It will apply the change and reboot the Device.



- ix. Please make sure the subnet of PC IP address and IP CAM IP address are the same.

The same Subnet:

IP CAM IP address: 192.168.1.200

PC IP address: 192.168.1.100

Different Subnets:

IP CAM IP address: 192.168.2.200

PC IP address: 192.168.1.100

To Change PC IP address:

Control Panel → Network Connections → Local Area Connection Properties → Internet Protocol (TCP/IP) → Properties

Please make sure your IP Camera and PC have the same Subnet. If not, please change IP Camera subnet or PC IP subnet accordingly.

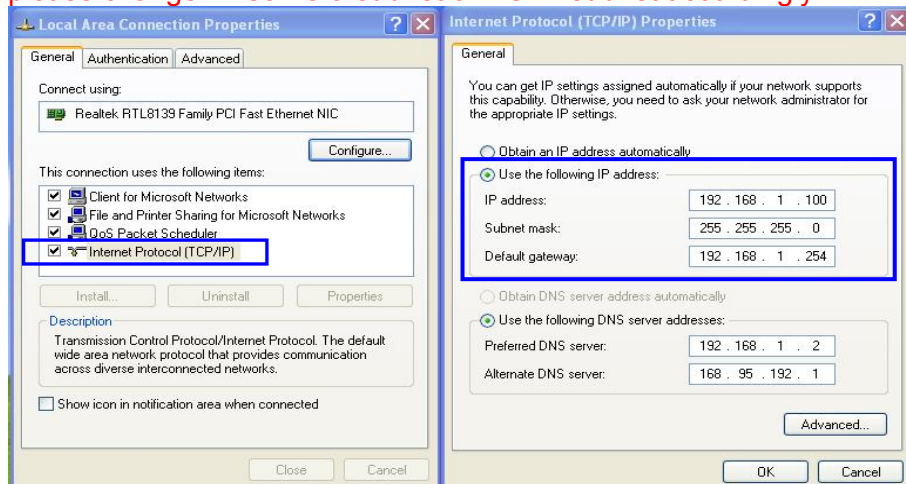

- x. A quick way to access remote monitoring is to left-click the mouse twice on a selected IP Camera listed on “Device list” of IP Installer. An IE browser will be opened.

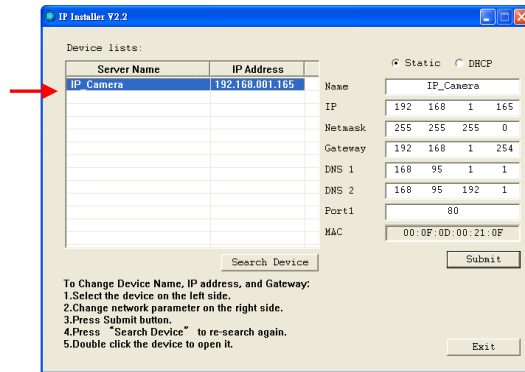

- xi. Then, please key in the default “user name: admin” and “password: admin”.



D. Install ActiveX control:

For the first time to view the camera video via IE, it will ask you to install the ActiveX component.

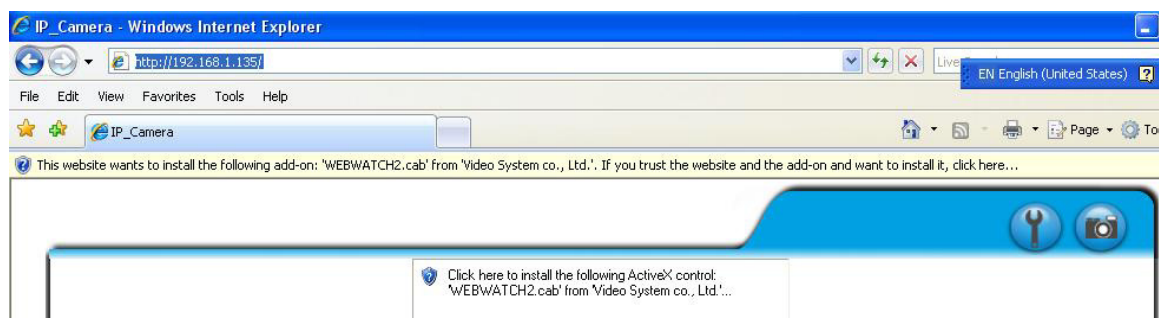

If the installation failed, please check the security setting for the IE browser.

- i. IE → Tools → Internet Options... → Security Tab → Custom Level... → Security Settings → Download unsigned ActiveX controls → Select “Enable” or Prompt.
- ii. IE → Tools → Internet Options... → Security Tab → Custom Level... → Initialize and script ActiveX controls not marked as safe → Select “Enable” or Prompt.

1

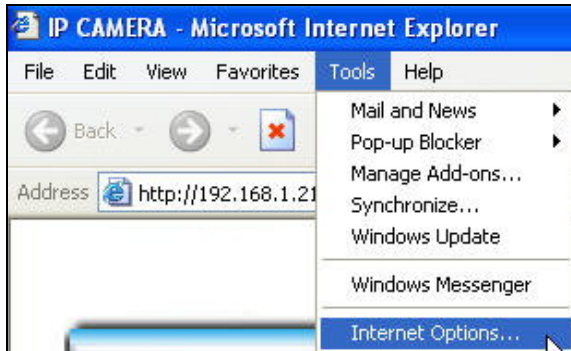

2

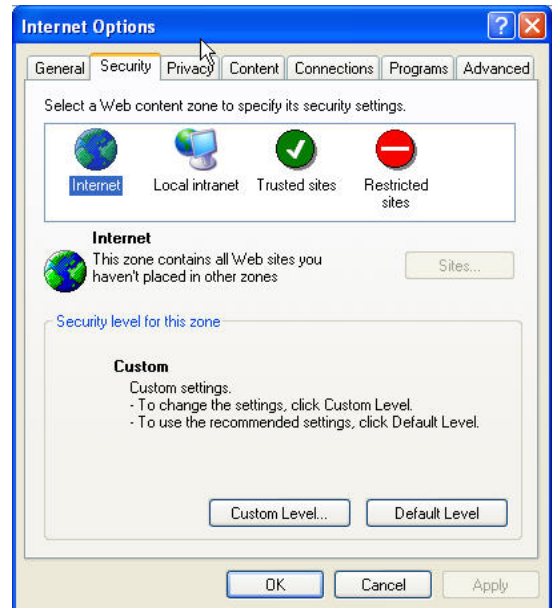

3

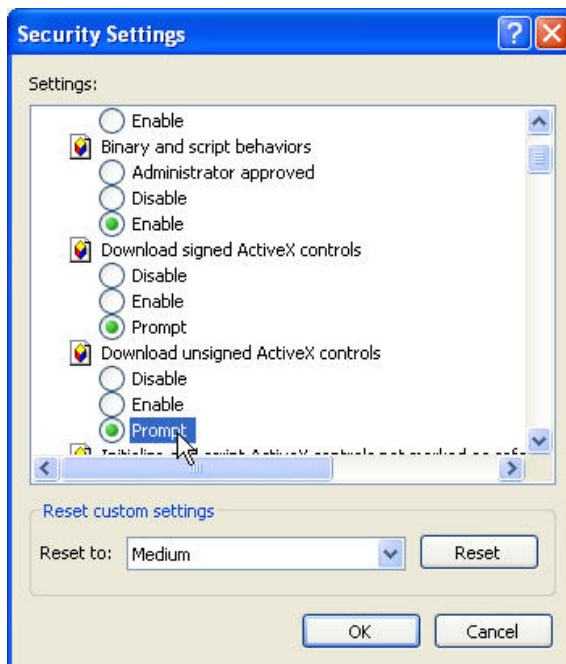

4

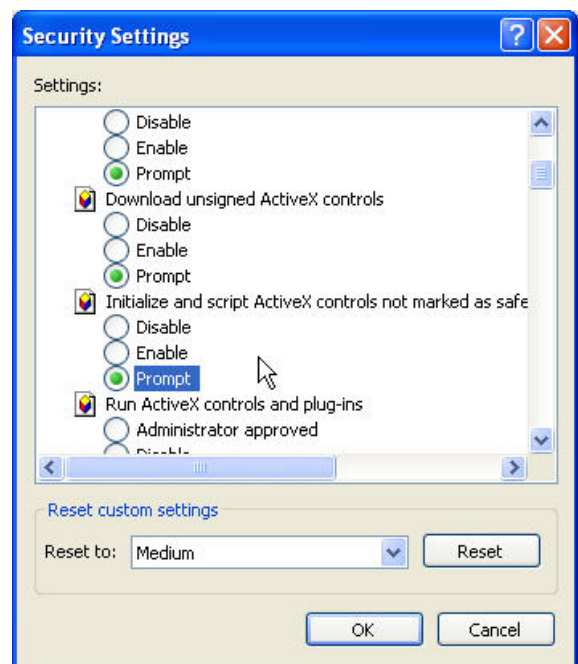

5

When popup the following dialogue box, click "Yes".

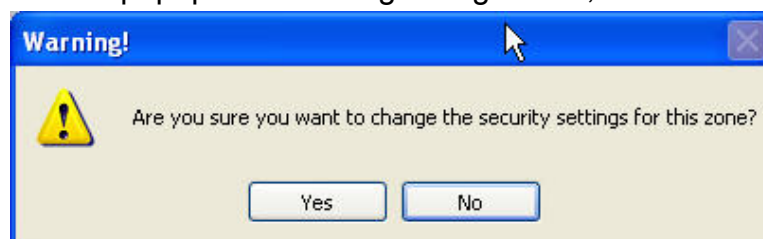

IV. Live Video

Start a IE browser, type the IP address of the IP camera in the address field. It will show the following dialogue box. Key-in the user name and password. The default user name and password are “**admin**” and “**admin**”.

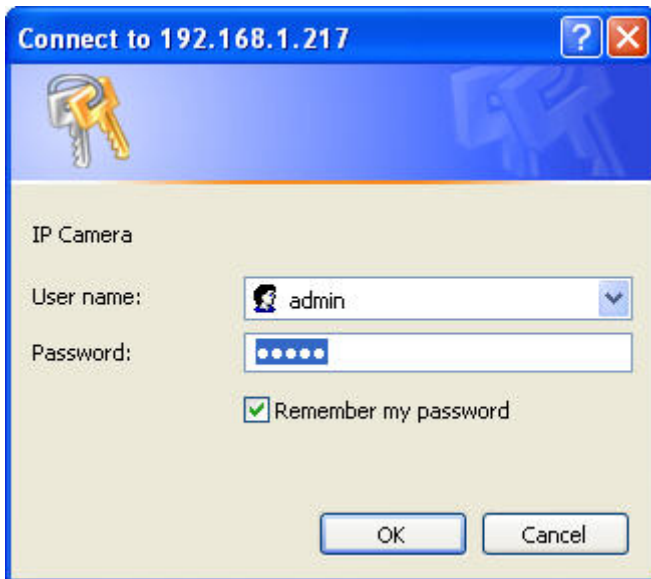

When connect to the IP CAMERA ◦ The following program interface shows.



1.  : Get into the administration page

2.  : Video Snapshot

3. Show system time, video resolution, and video refreshing rate

4. Select video streaming source **(When streaming 2 setting in 『Video Setting』 is closed, this function will not display)**

5. IP Camera supports 2-way audio. Click the “Chatting” check box. Then you can use microphone which connects to the PC to talk to server side, which is IP Camera side

6. Shows how many people connect to this IP camera

7. Control the relay which is connected to this camera.

Double-click the video, it will change to full screen mode. Press “Esc” or double-click the video again, it will change back to normal mode.

Right-Click the mouse on the video, it will show a pop-up menu.



1. Snapshot : Save a JPEG picture

2. Record Start : Record the video in the local PC. It will ask you where to save the video. To stop recording, right-click the mouse again. Select “Record Stop”. The video format is AVI. Use Microsoft Media Player to play the recorded file.

3. Mute : Turn of the audio. Click again to turn on it.

4. Full Screen : Full-screen mode.

5. ZOOM: Enable zoom-in and zoom-out functions. Select “Enable digital zoom” option first within the pop-up dialogue box and then drag and drop the bar to adjust the zoom factors.

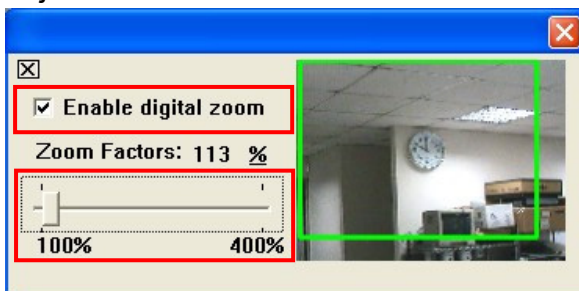

V. Configuration



Click



to go back to the live

video page.

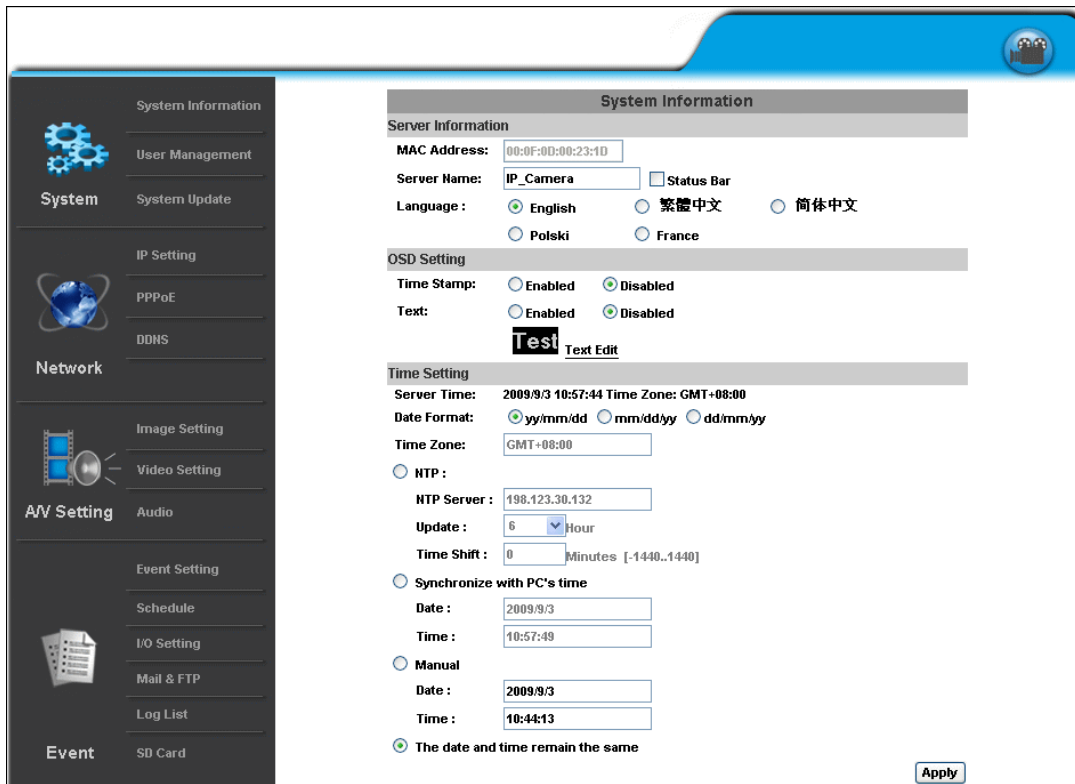

The screenshot displays the configuration web interface for an IP camera. On the left is a navigation sidebar with categories: System (containing System Information, User Management, System Update), Network (containing IP Setting, PPPoE, DDNS), A/V Setting (containing Image Setting, Video Setting, Audio), and Event (containing Event Setting, Schedule, I/O Setting, Mail & FTP, Log List, SD Card). The main content area is titled 'System Information' and is divided into several sections:

- Server Information:** Includes fields for MAC Address (00:0F:00:00:23:1D), Server Name (IP_Camera), and a checkbox for Status Bar. Language options are English (selected), 繁體中文, 简体中文, Polski, and France.
- OSD Setting:** Includes Time Stamp and Text options, both with Enabled and Disabled radio buttons. The Text field contains 'Test' and is labeled 'Text Edit'.
- Time Setting:** Shows the current Server Time as 2009/9/3 10:57:44 with a Time Zone of GMT+08:00. It offers Date Format options: yy/mm/dd (selected), mm/dd/yy, and dd/mm/yy. The Time Zone is set to GMT+08:00.
- NTP:** Includes an NTP Server field (198.123.30.132), an Update interval of 6 hours, and a Time Shift of 0 minutes.
- Synchronize with PC's time:** Includes Date (2009/9/3) and Time (10:57:49) fields.
- Manual:** Includes Date (2009/9/3) and Time (10:44:13) fields.
- Radio buttons:** There are radio buttons for 'Synchronize with PC's time', 'Manual', and 'The date and time remain the same' (which is selected).

An 'Apply' button is located at the bottom right of the configuration area.

A. System

i. System Information

- a. Server Information: Set up the camera name, select language, and set up the camera time.
 1. Server Name : This is the Camera name. This name will show on the IP Installer.
 2. Select language : There are English, Traditional Chinese, and Simplified Chinese to select. When change, it will show the following dialogue box for the confirmation of changing language.



- b. OSD Setting: Select a position where date & time stamp / text showing on screen.



Moreover, click Text Edit can entry to adjust the OSD contents which is including Size and Alpha of text. Finally, click **Upgrade** button to reserve the setting.

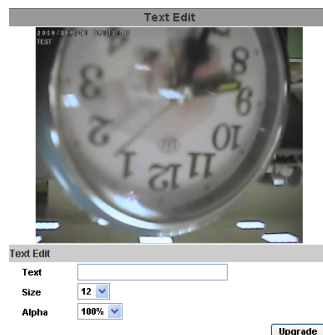

- c. Server time setting : Select options to set up time - "NTP", "Synchronize with PC's time", "Manual", "The date and time remain the same".

Time Setting

Server Time: 2007/4/11 14:56:01 Time Zone: GMT+08:00

Date Format: yy/mm/dd mm/dd/yy dd/mm/yy

Time zone: GMT+08:00

NTP :
 NTP Server : GMT-09:00
 GMT-08:00
 GMT-07:00
 GMT-06:00
 GMT-05:00
 GMT-04:00
 GMT-03:30
 GMT-03:00
 GMT-02:00
 GMT-01:00
 GMT-00:00
 GMT+01:00
 GMT+02:00
 GMT+03:00
 GMT+03:30
 GMT+04:00
 GMT+04:30
 GMT+05:00

Synchronize
 Date :
 Time :

Manual
 Date :
 Time :

The date and time are the same

ii . User Management

IP CAMERA supports three different users, administrator, general user, and anonymous user.

User Management

Anonymous User Login

YES NO

Add User

Username:

Password:

Confirm:

User List

Username	User Group	Modify	Remove
admin	Administrator	Edit	

- a. Anonymous User Login :
 Yes : Allow anonymous login
 No : Need user name & password to access this IP camera
- b. Add user :
 Type the user name and password, then click "Add/Set".
- c. Click "edit" or "delete" to modify the user.



iii、 System update :

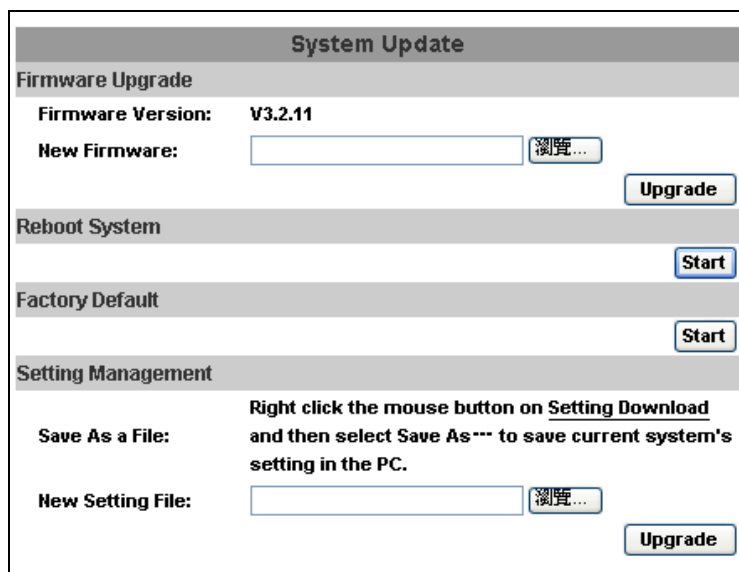

- a. To update the firmware online, click “Browse...” to select the firmware. Then click “Upgrade” to proceed.
- b. Reboot system : re-start the IP camera
- c. Factory default : delete all the settings in this IP camera.
- d. Setting Management : User may download the current setting to PC, or upgrade from previous saved setting.
 1. Setting download:
Right-click the mouse button on Setting Download → Select “Save AS...” to save current IP CAM setting in PC → Select saving directory → Save
 2. Upgrade from previous setting
Browse → search previous setting → open → upgrade → Setting update confirm → click [index.html](#). to return to main page

B.Network

i. IP Setting

IP Camera supports DHCP and static IP.

IP Setting	
IP Assignment	
<input type="radio"/> DHCP	
<input checked="" type="radio"/> Static	
IP Address:	<input type="text" value="192.168.1.200"/>
Subnet Mask:	<input type="text" value="255.255.255.0"/>
Gateway:	<input type="text" value="192.168.1.254"/>
DNS 0:	<input type="text" value="168.95.1.1"/>
DNS 1:	<input type="text" value="168.95.192.1"/>
Port Assignment	
Web Page Port:	<input type="text" value="80"/>
RTSP Port :	<input type="text" value="554"/>
RTP Start Port:	<input type="text" value="5000"/> [1024..10000]
RTP End port:	<input type="text" value="9000"/> [1025..10000]
UPnP	
UPnP:	<input checked="" type="radio"/> Enabled <input type="radio"/> Disabled
<input type="button" value="Apply"/>	

- a. DHCP : Using DHCP, IP Camera will get all the network parameters automatically.
- b. Static IP : Please type in IP address, subnet mask, gateway, and DNS manually.
- c. Port Assignment: user may need to assign different port to avoid conflict when setting up IP assignment.
 1. Web Page Port: setup web page connecting port and video transmitting port (Default: 80)
 2. RTSP Port: setup port for RTSP transmitting (Default: 554)
 3. RTP Start and End Port: in RTSP mode, you may use TCP and UDP for connecting. TCP connection uses RTSP Port (554). UDP connection uses RTP Start and End Port.

d. UPnP

This IP camera supports UPnP, If this service is enabled on your computer, the camera will automatically be detected and a new icon will be added to “My Network Places.”

Note: UPnP must be enabled on your computer.

Please follow the procedure to activate UPnP

1. open the Control Panel from the Start Menu
2. select Add/Remove Programs
3. Select Add/Remove Windows Components and open Networking Services section
4. Click Details and select UPnP to setup the service
5. The IP device icon will be added to “MY Network Places”
6. User may double click the IP device icon to access IE browser

ii \ PPPoE :

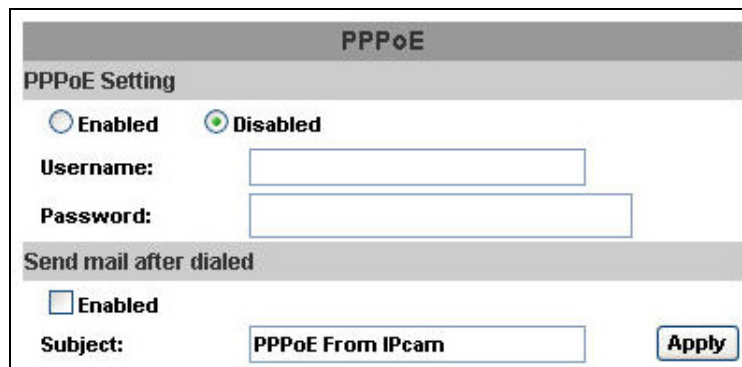

Select “Enabled” to use PPPoE.

Key-in Username and password for the ADSL connection.

Send mail after dialed : When connect to the internet, it will send a mail to a specific mail account. For the mail setting, please refer to “Mail and FTP” settings.

iii \ DDNS :

It supports DDNS (Dynamic DNS) service.

a. DynDNS :

DDNS

DDNS Setting

Enabled Disabled

Provider:

Hostname:

Username:

Password:

Schedule Update: Minutes

State

Idle

Note:

1. Schedule Update: Feature of DDNS schedule update is designed for IP products which installed behind the ICS or NAT devices. Update range from every 5 (minutes) to 5000 (minutes) and 0 remain to off.
2. Please note that the hostname will be blocked by DynDNS.org if schedule update is more than once every 5 minutes to 60 minutes. In general, schedule update in every 1440 minutes is recommended.

1. Enable this service
2. Key-in the DynDNS server name, user name, and password.
3. Set up the IP Schedule update refreshing rate.
4. Click "Apply"
5. If setting up IP schedule update too frequently, the IP may be blocked. In general, schedule update every day (1440 minutes) is recommended.

b. Camddns service :

DDNS

DDNS Setting

Enabled Disabled

Provider: ▼

Username:

Schedule Update: Minutes

State

Idle

Note:

- Schedule Update:** Feature of DDNS schedule update is designed for IP products which installed behind the ICS or NAT devices. Update range from every 5 (minutes) to 5000 (minutes) and 0 remain to off.
- Please note that the hostname will be blocked by DynDNS.org if schedule update is more than once every 5 minutes to 60 minutes. In general, schedule update in every 1440 minutes is recommended.

1. Please enable this service
2. Key-in user name.
3. IP Schedule update is default at 5 minutes
4. Click "Apply".

c. DDNS Status

1. Updating : Information update
2. Idle : Stop service
3. DDNS registration successful, can now log by
`http://<username>.ddns.camddns.com` : Register successfully.
4. Update Failed, the name is already registered : The user name has already been used. Please change it.
5. Update Failed, please check your internet connection : Network connection failed.
6. Update Failed, please check the account information you provide : The server, user name, and password may be wrong.

C. A/V Setting

i. Image Setting

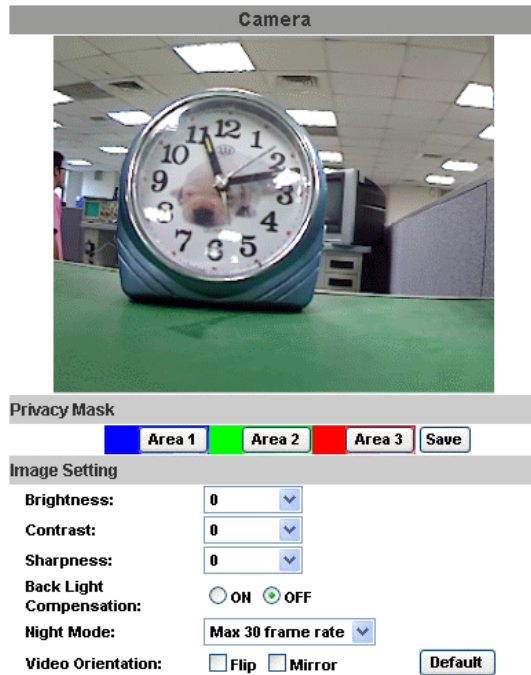

For the security purpose, there are three areas can be setup for privacy mask. Click Area button first and pull a area on the above image. Finally, click **Save** button to reserve the setting.

Adjust “Brightness”, “Contrast”, “Hue”, “Saturation” to get clear video.
Adjust “Brightness”, “Contrast”, “Hue”, “Saturation” to get clear video.

Moreover, IP CAMERA supports “Back Light Compensation”, “Night Mode” and “Video Orientation”.

- ii 、 This IP camera belongs to external varifocal lens adjustment camera. Please adjust “**ZOOM**” first and “**FOCUS**” in the following to complete the adjustment.

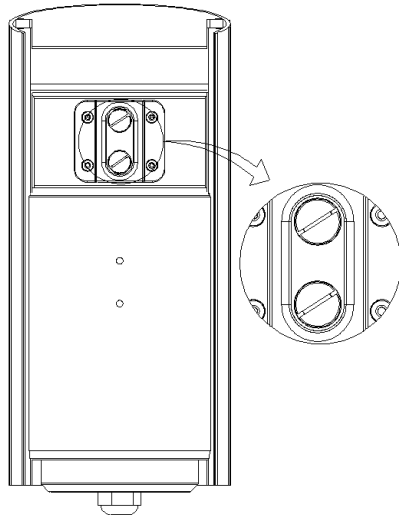

- iii 、 Video Setting

User may select 2 streaming output simultaneously:

Streaming 1 Setting: Basic mode and Advanced mode

Streaming 2 Setting: Basic mode, Advanced mode, and 3GPP mode

(Max Video Frame Rate for both streaming combined is 30 FPS)

- a. Video System: click the drop down list to select the Input Resolution, Video System and TV Output.

Video Setting
Input Resolution: 1600x1200 @ 15fps ▾
Video System: NTSC ▾
TV Output: Auto ▾ (Auto : Based on the Video System)

- b. Streaming 1 Basic Mode :

Streaming 1 Setting
 Basic Mode Advanced Mode
Resolution: 800x600 ▾
Quality: Best ▾
Video Frame Rate: 15 FPS ▾
Video Format: H.264 ▾
RTSP Path: ex:rtsp://</> Audio:G.711

1. Resolution :

There are 8 resolutions can be chosen.

1600x 1200, 1280x1024, 1280x960, 1280x720, 800x600, 640x480, 320x240, 176x144

2. Quality :

There are 5 levels to adjust:

Best/ High/ Standard/ Medium/ Low

The higher the quality is, the bigger the file size is. Also not good for internet transmitting

3. Video Frame Rate : The video refreshing rate per second.
4. Video Format : H.264 or JPEG
5. RTSP Path: RTSP output name

c. Streaming 1 Advanced Mode :

Streaming 1 Setting	
<input type="radio"/> Basic Mode	<input checked="" type="radio"/> Advanced Mode
Resolution:	800x600
Bitrate Control Mode:	<input type="radio"/> CBR <input checked="" type="radio"/> VBR
Video Quantitative:	9
Video Bitrate:	1.5Mbps
Video Frame Rate:	15 FPS
GOP Size:	1 X FPS <small>GOP = 15</small>
Video Format:	H.264
RTSP Path:	<input type="text"/> <small>ex:rtsp://</> Audio:G.711</small>

1. Resolution :

There are 8 resolutions can be chosen.

1600x 1200, 1280x1024, 1280x960, 1280x720, 800x600, 640x480, 320x240, 176x144

2. Bitrate Control Mode

There are CBR [Constant Bit Rate] and VBR [Variable Bit Rate] to use.

CBR : 32Kbps~4Mbps (the higher the CBR is, the better the video quality is)

VBR : 1(Low)~10(High) – Compression rate, the higher the compression rate, the lower the picture quality is; vise versa. The balance between VBR and network bandwidth will affect picture quality. Please carefully select the VBR rate to avoid picture breaking up or lagging.

3. Video Frame Rate

The video refreshing rate per second.

NTSC: Max 30 frames/second PAL: Max 25 frames/second

4. GOP Size

It means "Group of Pictures". The higher the GOP is, the better the quality is.

5. Video Format : H.264 or JPEG

6. RTSP Path: RTSP output connecting route

d. Streaming 2 Basic Mode :

Streaming 2 Setting

Basic Mode Advanced Mode

Resolution:

Quality:

Video Frame Rate:

Video Format:

RTSP Path: `ex:rtsp://</>/v2` Audio:G.711

1. Resolution :
There are 8 resolutions can be chosen.
1600x 1200, 1280x1024, 1280x960, 1280x720, 800x600, 640x480, 320x240, 176x144
 2. Quality :
There are 5 levels to adjust:
Best/ High/ Standard/ Medium/ Low
The higher the quality is, the bigger the file size is. Also not good for internet transmitting
 3. Video Frame Rate : The video refreshing rate per second.
 4. Video Format : H.264 or JPEG
 5. RTSP Path: RTSP output connecting route
- e. Streaming 2 Advanced Mode :

Streaming 2 Setting

Basic Mode Advanced Mode

Resolution:

Bitrate Control Mode: CBR VBR

Video Quantitative:

Video Bitrate:

Video Frame Rate:

GOP Size:

Video Format:

RTSP Path: `ex:rtsp://</>/v2` Audio:G.711

1. Resolution :
There are 8 resolutions can be chosen.
1600x 1200, 1280x1024, 1280x960, 1280x720, 800x600, 640x480, 320x240, 176x144
2. Bitrate Control Mode
There are CBR [Constant Bit Rate] and VBR [Variable Bit Rate] to use.

iv 、 Audio :

IP CAMERA supports 2-way audio. User can send audio from IP Camera Built-in mic to remote PC; User can also send audio from remote PC to IP Camera's external speaker.

- a. Audio from IP camera built-in mic to local PC: select "Enable" to start this function.

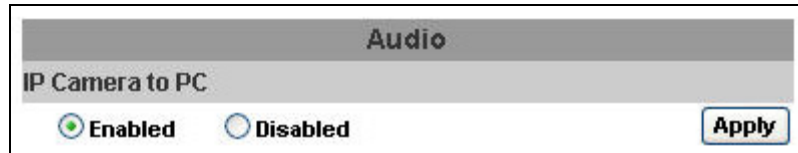

- b. Audio from local PC to IP Camera: Check "chatting" in the browsing page.

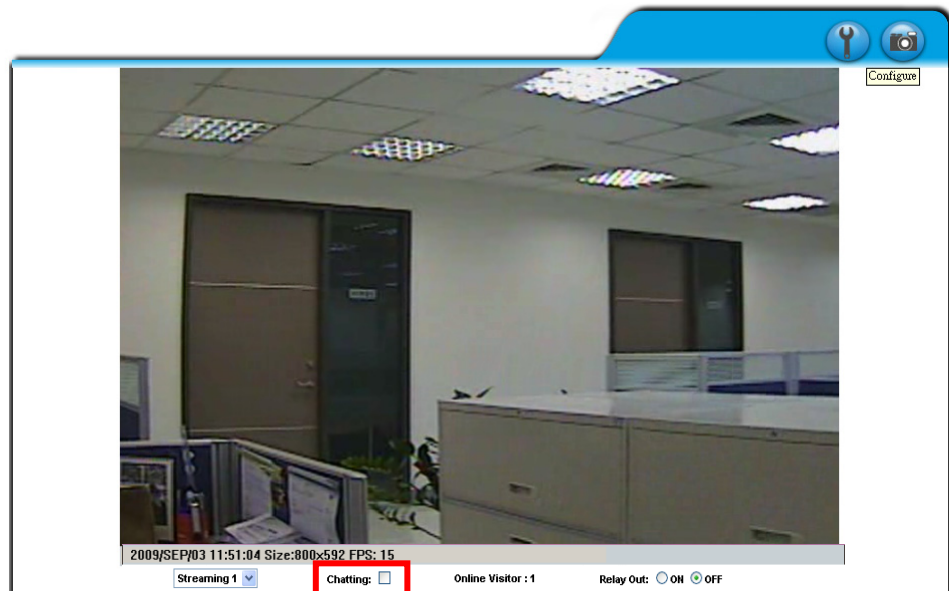

The Audio will not be smooth when enable SD card recording function simultaneously.

D.Event List

IP CAMERA provides multiple event settings.

i、 Event Setting

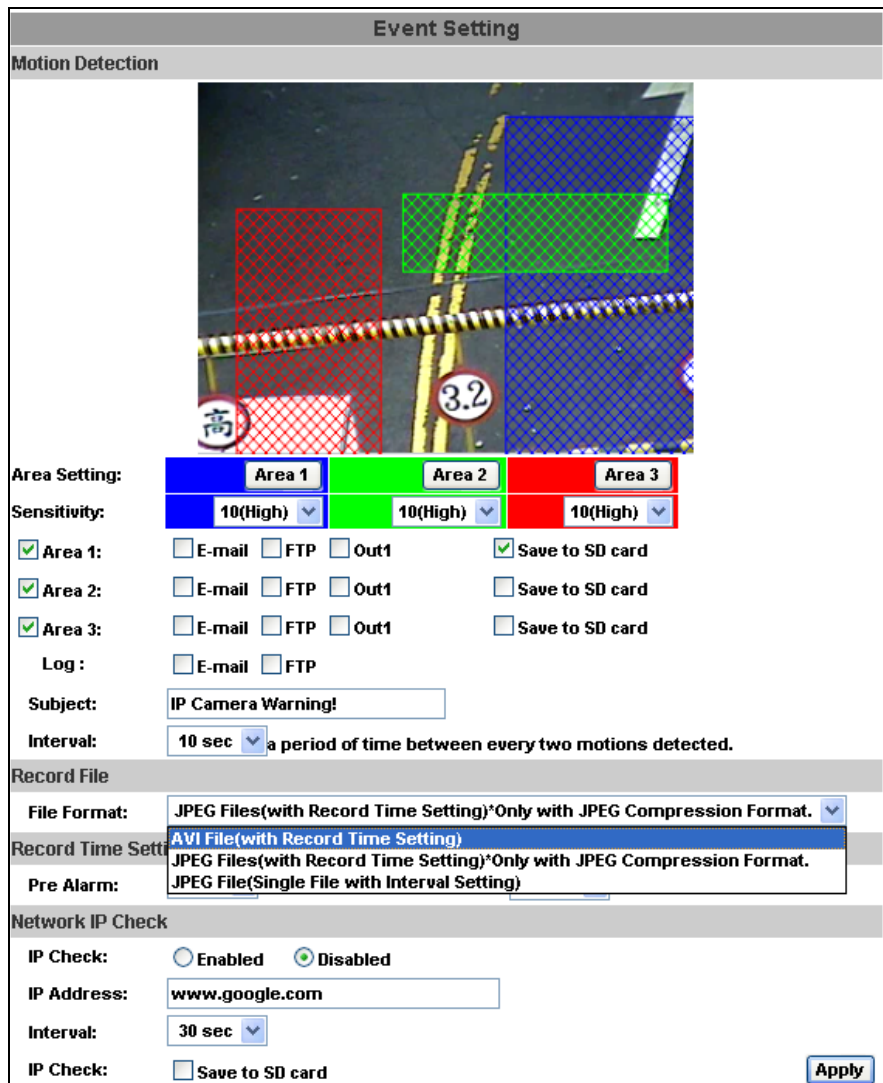

a. Motion Detection :

IP CAMERA allows 3 areas motion detection. When motion is triggered, it can send the video to some specific mail addresses, transmit the video to remote ftp server, trigger the relay, and save video to local SD card. To set up the motion area, click “Area Setting”. Using mouse to drag and draw the area. The same operation for area 2 and 3.

b. Record File Setting: IP CAMERA allows 3 different types of recording file to change its record size.

When motion/alarm is triggered, there are 3 different types of record mode.

1. AVI File (With Record File Setting)
 2. Multi-JPEG (With Record File Setting), only with JPEG compression format.
 3. Single JPEG (Single File with Interval Setting)
- c. Record Time Setting :
- Pre Alarm and Post Alarm setups for video start and end time when motion detected, I/O, or other devices got triggered.
- Note: Pre/Post Alarm record time is base on record time setting and IP Cam built-in Ram memory. Limited by IP Cam built-in Ram Memory, When information is too much or video quality set too high, it will cause recording frame drop or decrease on post alarm recording time.
- d. Network Dis-connected :
- When the network is down, it will save the video to local SD card.
This function is only enabled in wire connection.
- e. Network IP check
- When the connection is down, it records the video to SD card. Make sure the video recording is continuous. To use this function, key in the IP address of the PC which has recording software installed. Enable the function of "Save to SD card", then click "Apply".
The interval of two video files on SD card is fixed with 30 seconds.
- ii \ Schedule
- a. Schedule: After complete the schedule setup, the camera data will be recorded according to the schedule setup.
 - b. Snapshot: After enable the snapshot function, user can select the storage position of snapshot file, the interval time of snapshot and the reserved file name of snapshot.

Schedule																								
All	0	1	2	3	4	5	6	7	8	9	10	11	12	13	14	15	16	17	18	19	20	21	22	23
Mon.																								
Tue.																								
Wed.																								
Thu.																								
Fri.																								
Sat.																								
Sun.																								

With schedule setup.

Snapshot	
<input type="radio"/> Enabled <input checked="" type="radio"/> Disabled	
Snapshot:	<input type="checkbox"/> E-mail <input type="checkbox"/> FTP <input type="checkbox"/> Save to SD card
Interval:	<input type="text" value="10"/> Second(s) [1..50000]
File Name:	<input type="text" value="Snapshot"/>

iii 、 I/O Setting

IP CAMERA supports 1 input/ 1 output. When input is triggered, it can send the video to some specific mail addresses, transmit the video to remote ftp server, trigger the relay, and save video to local SD card.

I/O Setting	
Input Setting	
Input 1 Sensor:	<input type="text" value="N.O"/>
Input 1 Action:	<input type="checkbox"/> E-mail <input type="checkbox"/> FTP <input checked="" type="checkbox"/> Out1 <input type="checkbox"/> Save to SD card
Subject:	<input type="text" value="GPIO In Detected!"/>
Interval:	<input type="text" value="10 sec"/>
<input type="checkbox"/> Based on the schedule	
Output Setting	
Mode Setting:	<input checked="" type="radio"/> OnOff Switch <input type="radio"/> Time Switch
Interval:	<input type="text" value="10 sec"/>

CATUTION!!

Please connect to propriety relay output device to reduce the risk of electric shock & damaged.

Alarm Input Setting

Among alarm input setting, the user can setup the connected device which can send the signal to “relay output” when the device is triggered.

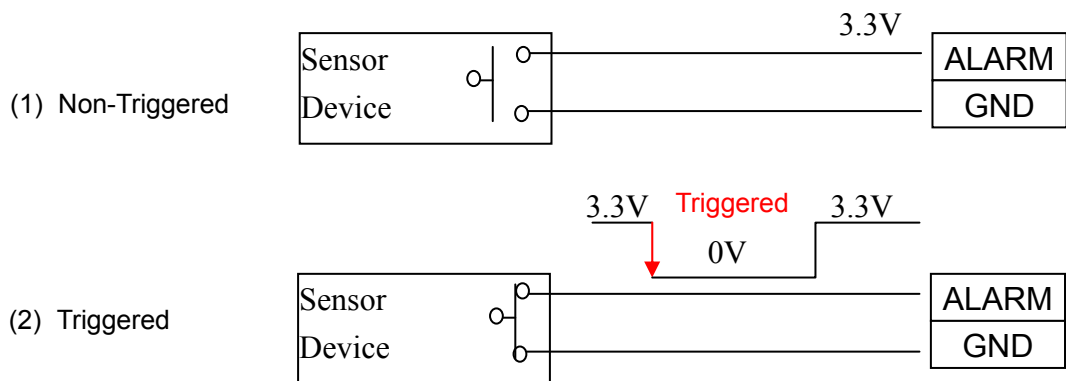

Relay Output Setting

In relay output setting, the user can setup the output device to perform the related output action.

I/O PIN definition, please refer to the following statement

ALARM	ALARM INPUT
GND	Standard Voltage: 3.3V (internal Voltage) Connect "ALARM" and "GND" two pins.
N.C.	RELAY OUTPUT
COM	Contact Rating: 30V DC/ 1A, 125V AC/ 0.3A Depends on the devices, the user should connect "N.C." and "COM" pins or "N.O." and "COM" pins
N.O.	

RELAY INSTALLATION EXAMPLE 1

Trigger a normal off (Normal Open) alarm siren on when event/motion occur at COM:

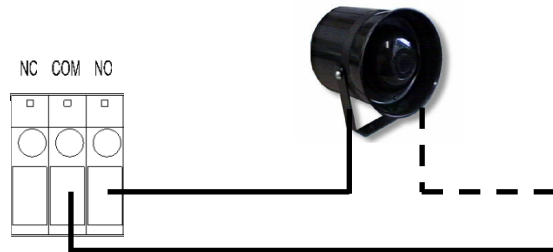

RELAY INSTALLATION EXAMPLE 2

Trigger the normal on (Normal Close) indoor illumination off when event / motion occur at COM:

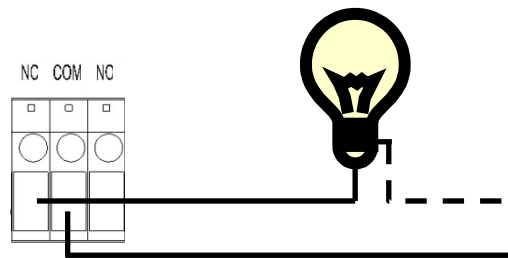

iv 、 Mail & FTP

To send out the video via mail of ftp, please set up the configuration first.

Mail & FTP	
Mail Setting	
Mail Server:	<input type="text"/>
Username:	<input type="text"/>
Password:	<input type="text"/>
Sender's Mail:	<input type="text"/>
Receiver's Mail:	<input type="text"/>
Bcc Mail:	<input type="text"/>
FTP Setting	
FTP Server:	<input type="text"/>
Username:	<input type="text"/>
Password:	<input type="text"/>
Port:	<input type="text" value="21"/>
Path:	<input type="text" value="/"/>
<input type="button" value="Apply"/>	

v 、 Log List

Log List	
System Logs	Logs
Motion Detection Logs	Logs
I/O Logs	Logs
All Logs	Logs

Sort by System Logs, Motion Detection Logs and I/O Logs. In addition, System Logs and I/O Logs won't lose data due to power failure.

vi 、 SD card

Please Insert SD card before use it. Make sure pushing SD card into the slot completely.

Note : The use of the SD card will affect the operation of the IP CAMERA slightly, such as affecting the frame rate of the video.

a. Playback :



1. It will show the capacity of the SD card. Click the date listed on this page. It will show the list of the video.

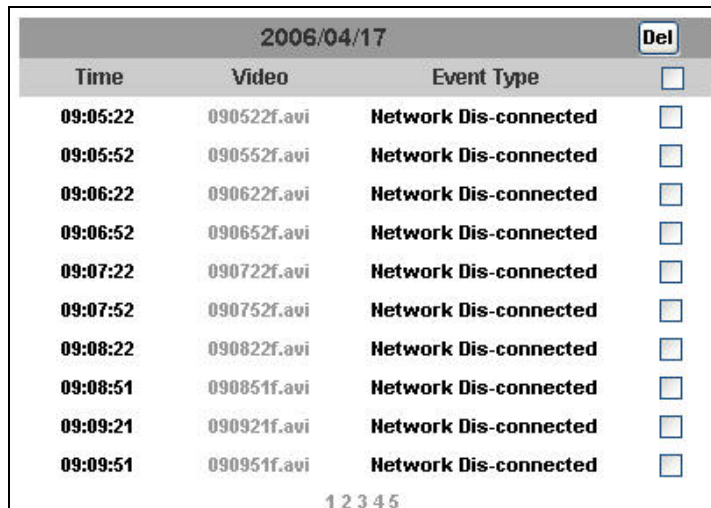

The screenshot shows a table of video files for the date 2006/04/17. The table has columns for Time, Video, Event Type, and a checkbox. A 'Del' button is located in the top right corner. Below the table, there are page numbers 1 2 3 4 5.

2006/04/17			Del
Time	Video	Event Type	<input type="checkbox"/>
09:05:22	090522f.avi	Network Dis-connected	<input type="checkbox"/>
09:05:52	090552f.avi	Network Dis-connected	<input type="checkbox"/>
09:06:22	090622f.avi	Network Dis-connected	<input type="checkbox"/>
09:06:52	090652f.avi	Network Dis-connected	<input type="checkbox"/>
09:07:22	090722f.avi	Network Dis-connected	<input type="checkbox"/>
09:07:52	090752f.avi	Network Dis-connected	<input type="checkbox"/>
09:08:22	090822f.avi	Network Dis-connected	<input type="checkbox"/>
09:08:51	090851f.avi	Network Dis-connected	<input type="checkbox"/>
09:09:21	090921f.avi	Network Dis-connected	<input type="checkbox"/>
09:09:51	090951f.avi	Network Dis-connected	<input type="checkbox"/>

2. The video format is AVI. Click the video to start Microsoft Media Player to play it.
3. To delete the video, check it, then click Del. When the SD card is full, it will remove the oldest video automatically.

VI. Network Configuration

i \ Configuration 1 :

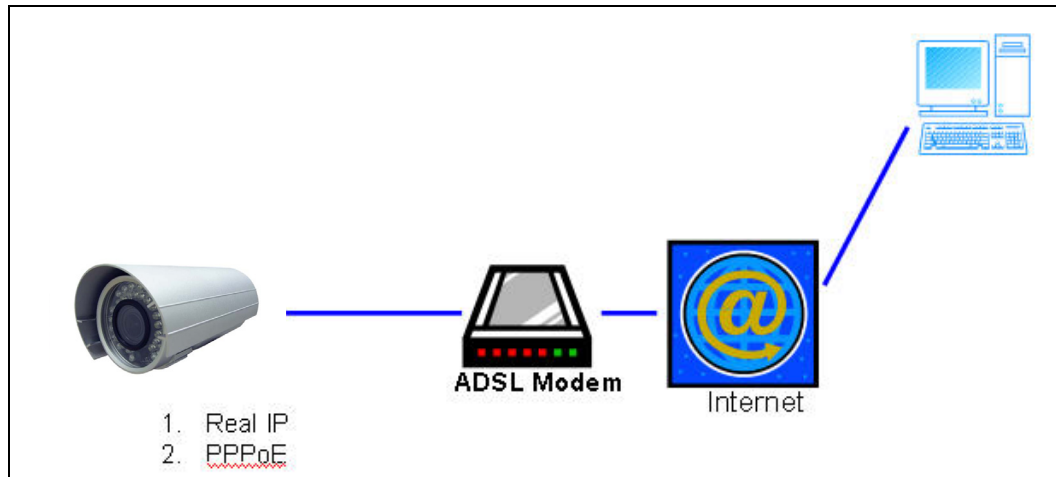

- a. Internet Access : ADSL or Cable Modem
- b. IP address : One real IP or one dynamic IP
- c. Only IP CAMERA connects to the internet
- d. For fixed real IP, set up the IP into IP CAMERA. For dynamic IP, start PPPoE.

ii \ Configuration 2 :

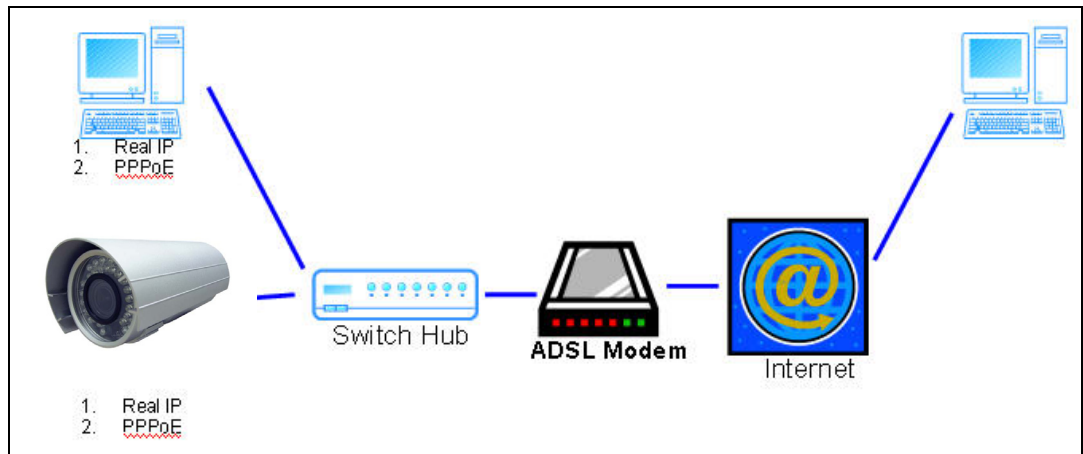

- a. Internet Access : ADSL or Cable Modem
- b. IP address : More than one real IP or one dynamic IP
- c. IP CAMERA and PC connect to the internet
- d. Device needed : Switch Hub
- e. For fixed real IP, set up the IP into IP CAMERA and PC. For dynamic IP, start PPPoE.

iii 、 Configuration 3 :

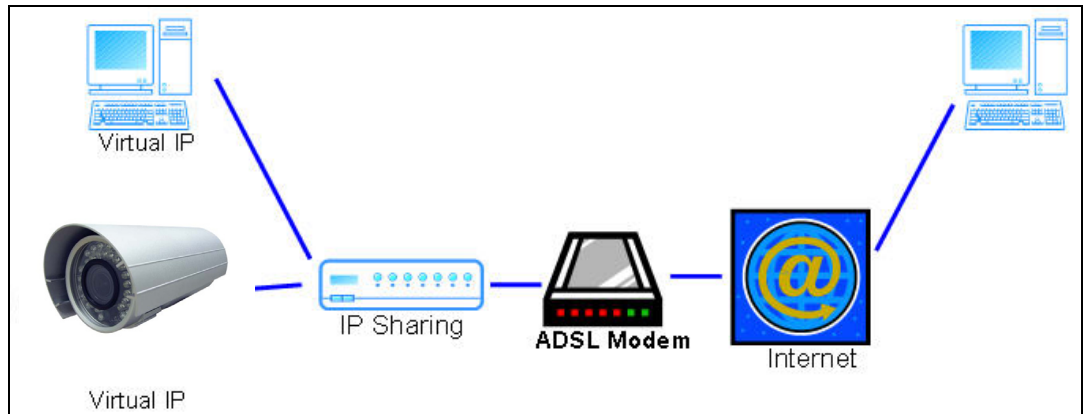

- a. Internet Access : ADSL or Cable Modem
- b. IP address : one real IP or one dynamic IP
- c. IP CAMERA and PC connect to the internet
- d. Device needed : IP sharing
- e. Use virtual IP, set up port forwarding in IP sharing.

VII. Factory Default

- i \ Removing an Ethernet cable.
- ii \ Plugging “a pink default cable” into “GND”.
- iii \ Plug power cable.
- iv \ When camera starts again, please remove the pink default cable and plug Ethernet cable for new setting.
- v \ Release the button when camera finishes proceed.
Re-login the camera using the default IP (<http://192.168.1.200>), and user name (admin), password (admin).

VIII. Package contents

- i \ IP CAMERA Network Camera
- ii \ Adaptor
- iii \ Ethernet Cable
- iv \ CD title (User manual, IP installation Utility)

Appendix I

SD Card Recommended :

SanDisk 128M	SanDisk 8GB
SanDisk 256M	SanDisk 16GB
SanDisk 512M	SanDisk 32GB
SanDisk 1G	Transcend 4GB
SanDisk 2G	Transcend 8GB
SanDisk 4G	Transcend 16GB
	Transcend 32GB